

# MESA ALTA

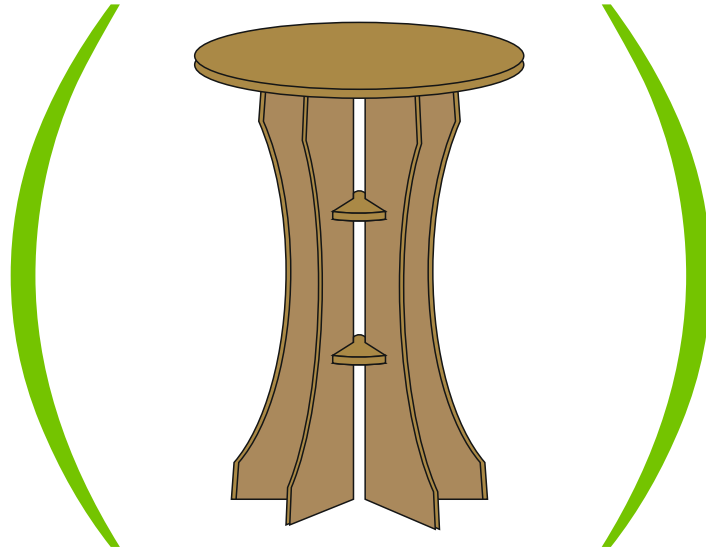

A  
X1

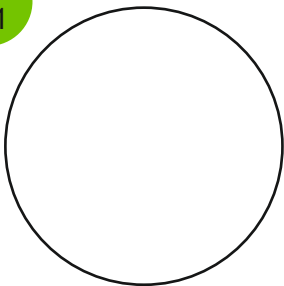

B  
X1

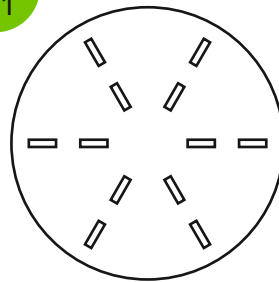

C  
X2

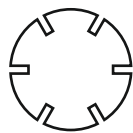

D  
X6

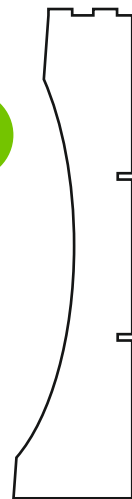

PASO  
1

- Unir A y B, pegar las dos piezas con silicona térmica.

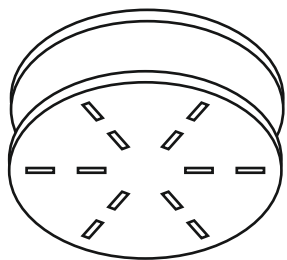

PASO  
2

- Encajar las piezas C en las ranuras de D.

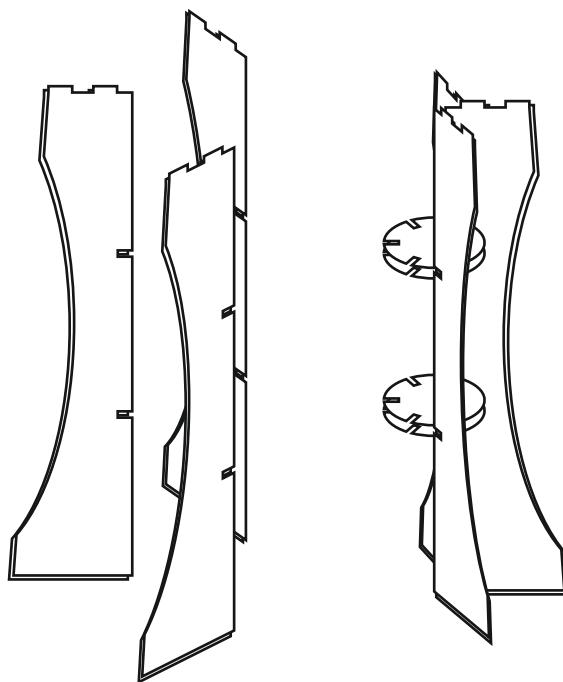

PASO  
3

- Encajar los dos grupos.

